

TOF/Start

Installation and Operation Manual



CEDES AG is certified according to ISO 9001: 2015

English

Pages

2 – 11

Contents

1.	About this manual	
1.1	Measurements	
1.2	Related documents	
1.3	CEDES headquarters	
2.	Safety information	
2.1	Non-intended use	
3.	Symbols, safety messages	
3.1	Safety messages categories	
4.	Introduction	
4.1	Application	
4.2	Features of the TOF/Start	
4.3	Type description	
5.	Configuration	
5.1	Type of threshold setting	
6.	Installation	
7.	Input / Output description and electrical connection	
8.	Start-up	
9.	Timing diagram	
10.	LED signals	
11.	Cross-traffic	
12.	Blanking	
13.	Trouble shooting	
14.	Maintenance	
15.	Disposal	
16.	Technical data	
17.	Dimensions	10
17.1	Sensor	10
17.2	Mounting bracket	10

1. About this manual

- 2** This 'TOF/Start Installation and Operation Manual', with metric and US measurements is the original version.
- 2**
- 2** The version number is printed at the bottom of each page.
- 3** To make sure you have the latest version, visit www.cedes.com from where this manual and related documents can be downloaded.
- 3**

1.1 Measurements

- 4** Measurements are, if not stated otherwise, given in mm (non-bracketed numbers) and inches (numbers in brackets).
- 4**
- 4**

1.2 Related documents

- 4** TOF/Start datasheet
001 231 en
- 5**

1.3 CEDES headquarters

- 5** CEDES AG
Science Park
CH-7302 Landquart
6 Switzerland

7

7

8

8

9

9

9

10

10

10

2. Safety information

IMPORTANT READ BEFORE INSTALLATION!

The TOF/Start was developed and manufactured using state-of-the-art systems and technologies. However, injury and damage to the sensor can still occur.

To ensure safe conditions:

- ▶ Read all enclosed instructions and information.
- ▶ Follow the instructions given in this manual carefully.
- ▶ Observe all warnings included in the documentation and attached to the sensor.
- ▶ Do not use the sensor if it is damaged in any way.
- ▶ Keep the instruction manual on site.

The TOF/Start should only be installed by authorized and fully trained personnel! The installer or system integrator is fully responsible for the safe integration of the sensor. It is the sole responsibility of the planner and/or installer and/or buyer to ensure that this product is used according to all applicable standards, laws and regulations in order to ensure safe operation of the whole application.

Any alterations to the device by the buyer, installer or user may result in unsafe operating conditions. CEDES is not responsible for any liability or warranty claim that results from such manipulation.

Failure to follow instructions given in this manual and/or other documents related to the TOF/Start may cause customer complaints, serious call backs, damage, injury or death.

2.1 Non-intended use

The TOF/Start **must not** be used for:

- Protection of dangerous machines
- Equipment in explosive atmospheres
- Equipment in radioactive environments



Use only specific and approved safety devices for such applications, otherwise serious injury or death or damage to property may occur!

3. Symbols, safety messages

Symbol	Meaning
▶	Single instruction or measures in no particular order
1.	Sequenced instructions
2.	
3.	
•	List, in no order of importance
→	Reference to a chapter, illustration or table within this document
Important	Important information for the correct use of the sensor

3.1 Safety messages categories

Warning of serious health risks

WARNING
Serious health risks

Highlights critical information for the safe use of the sensor. Disregarding these warnings can result in serious injury or death.

- ▶ Follow the measures highlighted by the triangle-shaped arrows
- ▶ Consult the safety information in Chapter 2 of this manual

Caution of possible health risk

CAUTION
Possible health risks

Highlights critical information for the safe use of the sensor. Disregarding these warnings can result in injury.

- ▶ Follow the measures highlighted by the triangle-shaped arrows
- ▶ Consult the safety information in Chapter 2 of this manual

Notice of damage risk

NOTICE
Risk of damage

Disregarding these notices can lead to damage to the sensor, the door controller and/or other devices.

- ▶ Follow the measures highlighted by the triangle-shaped arrows

4. Introduction

The TOF/Start is a compact yet powerful sensor which detects people and objects approaching an escalator and speeds it up in time for them to step comfortably and safely aboard.

The TOF technology enables the TOF/Start to operate with all types of backgrounds without any need to recalibrate. Usually mounted under the handrails or flush mounted in the balustrade at the approach area, it offers excellent detection capability over an area of up to 2 m x 2 m with a beam angle of up to 70°.

There are two versions of the TOF/Start:

- The TOF/Start Basic offers people/object detection and a blanking function to blank out fixed objects, such as bollards.
- The TOF/Start Advanced offers these features plus a cross-traffic function.

4.1 Application

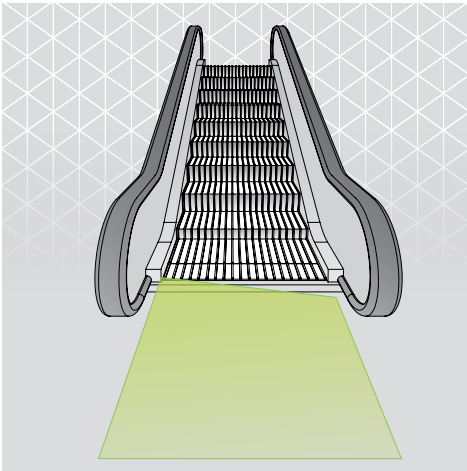

Figure 1: TOF/Start detects intending passengers approaching an escalator.

4.2 Features of the TOF/Start

- Excellent detection capability, independent of reflectance
- Ignores cross-traffic via intelligent direction recognition
- Individual setting of the detection area
- Detection area operates with all types of background
- Insensitive to ambient light

4.3 Type description

TOF/Start – a – bb – c – d – e – fff; h,h*i,i

<p>a : - Advanced B Basic</p> <p>bb : Aperture angle in °</p> <p>c : x-axis N Potentiometer</p> <p>d : y-axis N Potentiometer</p> <p>e : C Automatic calibration</p> <p>fff : 1PP Output - PNP/NPN (push-pull)</p> <p>g : - Non-blanking B Blanking</p> <p>h,h : x-axis Protection field in m</p> <p>i,i : y-axis Protection field in m</p>	}	<p>Threshold settings</p>
<p>h,h : x-axis Protection field in m</p> <p>i,i : y-axis Protection field in m</p>	}	<p>Only if Preset type</p>

Figure 2: Type description

5. Configuration

5.1 Type of threshold setting

The distance at which the sensor triggers an output is the threshold. The TOF/Start requires a threshold setting for the x-axis; note that the y-axis is fixed at 2 m. A factory setting as well as a mixture of potentiometer and preset are also possible. For requirements regarding a variable y-axis, please contact your local CEDES representative.

Note: The sensor uses a ±120 mm (±4.72 in) hysteresis. The hysteresis is the difference between the switching points changing the status from 'free field' to 'object detected' and back from 'object detected' to 'free field' compared to the nominal limit.

5.1.1 Threshold setting via potentiometer

The threshold distance at which the sensor triggers an output is set with a potentiometer for the x-axis on both the Basic and Advanced versions. This is done using the potentiometer at the back of the sensor. If the sensor points to a background, the distance of the switching threshold to the background is recommended to be set at 150 mm.

Important:

- ▶ The scale is not printed on the sensor. However the potentiometer can be adjusted in five fixed steps of 0.2 m; starting at 0.6 m (at the 7 o'clock position) up to 1.4 m (at the 5 o'clock position); see Figure 3 below.
- ▶ Take a small screw driver and turn the potentiometer to the required position.

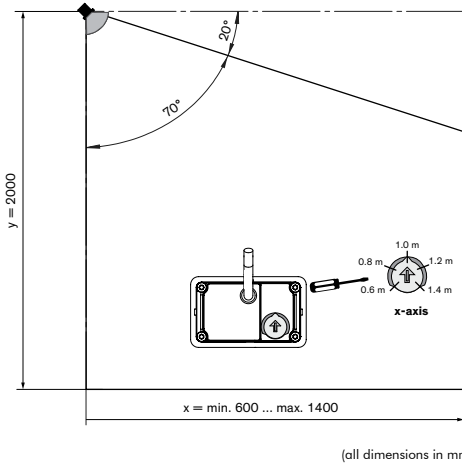

Figure 3: Detection area using potentiometer

Parameter	Value
Width (x-axis)	Min.: 600 mm Max.: 1,400 mm
Length (y-axis)	2,000 mm
Aperture angle	70°

Table 1: Parameter - detection area

6. Installation

Important:

The TOF/Start must be mounted under the handrail at a **minimum 10° mounting angle** to the ground facing upwards.

Figure 4: Mounting angle of TOF/Start

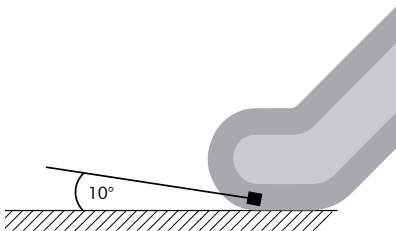

7. Input / Output description and electrical connection

Generally the TOF/Start has one output that is triggered if the detection field is interrupted. For this purpose, a push-pull output is used. With the logic selector (gray wire, Figure 6), the logic of the output signal can be configured for "HIGH" on object or "LOW" on object operation (Figure 5), according to the controller requirements.

The logic selection is performed during start-up.

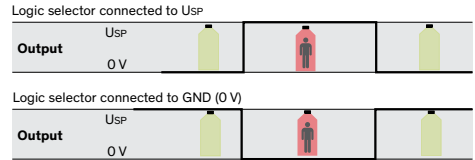
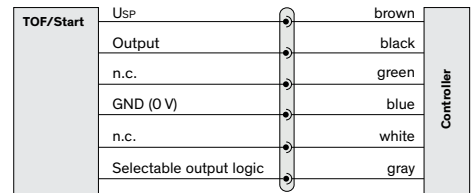

Figure 5: Output (PNP/NPN) logic



n.c. = not connected and isolated

Figure 6: Connection diagram

8. Start-up

1. Switch on mains and power up.
2. Check if LED lights up.
3. Check the distance setting and the reaction of the sensor, including the status LED, by placing an object into the detection area at different heights and widths.

9. Timing diagram

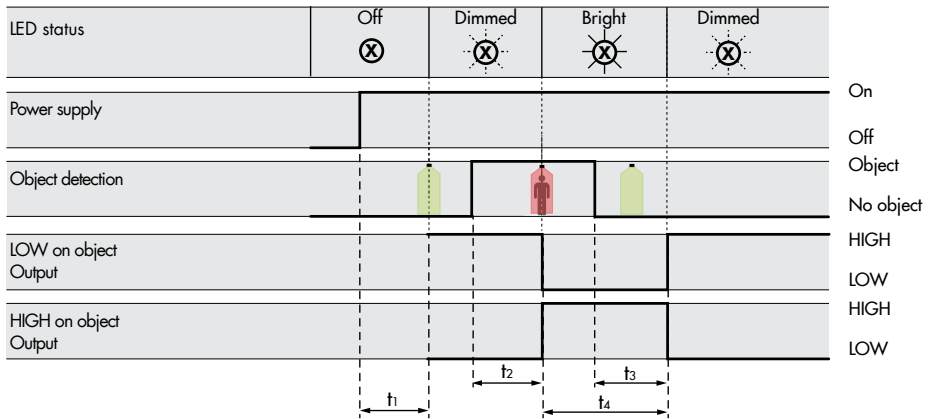

Figure 7: General timing diagram

	Time	Value [ms]
Power-on time	t_1	1,000
Max. response time	t_2	
- TOF/Start Basic		200
- TOF/Start Advanced		
• Area without cross-traffic < 1 m		200
• Area with cross-traffic > 1 m		400
Release time	t_3	200
Min. switching time	t_4	200

Figure 8: General timing table

10. LED signals

The red LED provides the sensor's status. The respective LED is dimmed when the power is OK and the detection field is free. The LED glows bright when an object is detected and the respective output triggered. The LED is visible from the front.

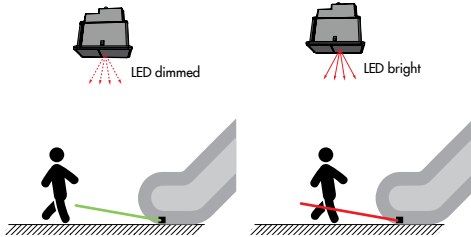

Figure 9: LED indicator

LED status	Description
LED off	No power
LED dimmed red	No object detected
LED bright red	Object detected

11. Cross-traffic

The TOF/Start Advanced features a cross traffic detection function. If a person moves **towards** the escalator entrance area, the TOF/Start Advanced triggers the output. If the person only moves **across** the escalator entrance area, the TOF/Start Advanced recognizes that the person does not wish to use the escalator and does not trigger the output.

Important:

The cross-traffic activation zone begins at a 1 meter distance from the sensor.

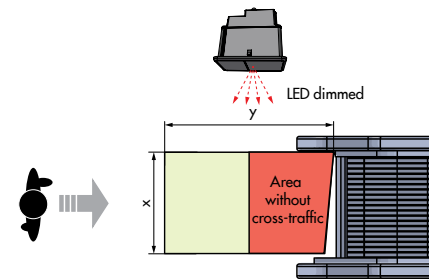

Figure 10: Detection field free; person moves towards the escalator entrance area. LED status is dimmed.

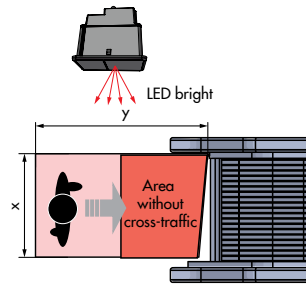

Figure 11: Person is detected entering detection area, moving towards the escalator entrance area. LED status is bright.

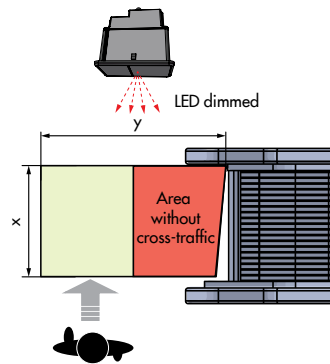

Figure 12: Detection field free; Person moves to cross the escalator entrance area. LED status is dimmed.

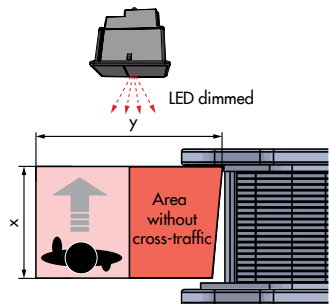

Figure 13: Sensor recognizes the person is moving cross the escalator entrance. LED status remains dimmed → no output switched.

12. Blanking

Both TOF/Start versions feature a blanking function. The TOF/Start triggers the output when objects are dynamic (moving) within the detection field. Static objects within the detection field will be ignored and blanked out (after 30 seconds). This covers with objects that are already present at power up (i.e. bollards).

Start-up:

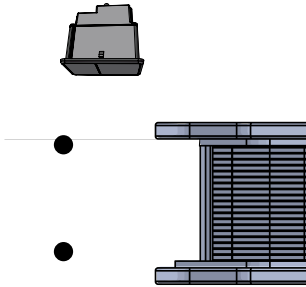

Figure 14: Active blanking - start-up sequence with i.e. bollards.

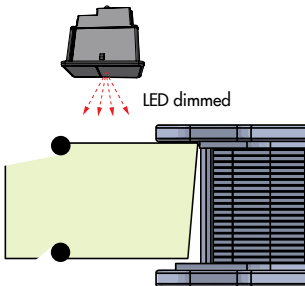

Figure 15: After start-up the bollards are blanked out from the detection field.

Active blanking:

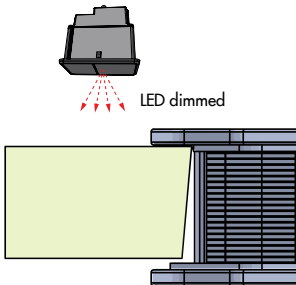

Figure 16: The detection field is free.

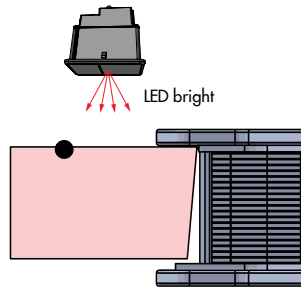

Figure 17: A static object is placed in the detection field (i.e a trash bag). The object will be detected.

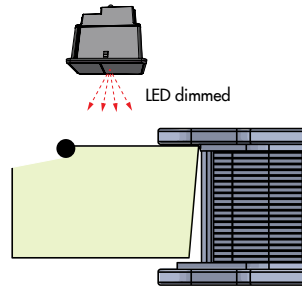

Figure 18: After 30 s the static object will be blanked out and the TOF/Start continues its operation with the new geometry of the detection field.

13. Trouble shooting

Status	Action
LED off	<ul style="list-style-type: none"> ▶ Check supply power ▶ Check electrical connections
Object in the safeguarded area and LED dimmed red	<ul style="list-style-type: none"> ▶ Check distance setting
No object in the safeguarded area and LED bright red	<ul style="list-style-type: none"> ▶ Check electrical connections ▶ Check distance setting

If the problem persists, please contact your local CEDES representative (www.cedes.com).

14. Maintenance

Although the TOF/Start does not need regular maintenance, a periodical functional check is strongly recommended as follows:

- ▶ Check the mounting position and detection area of the sensor.
- ▶ Clean the optical window with a soft towel and a little soapy water.

NOTICE

Damage to the optical window

- ▶ Never use any solvents, cleaners or mechanically abrasive towels or highpressure water to clean the sensors.

15. Disposal

The TOF/Start should only be replaced if a similar protection device is installed. Disposal should be done using the most up-to-date recycling technology according to local regulations and laws. There are no harmful materials used in the design and manufacture of the sensor. Traces of such dangerous materials may be found in the electronic components but not in the quantities that are harmful.

16. Technical data

Optical

Detection area	
- Length (y-axis)	2,000 mm
- Width (x-axis)	Min. 600 mm Max. 1,400 mm

Mechanical

Dimensions (w × h × l)	57 × 34 × 44.5 mm
Housing material	Polycarbonate
Housing color	Black
Enclosure rating	IP65
Temperature range	-20 °C ... +65 °C

Electrical

Supply voltage U _{sp}	24 VDC ±20%
Current consumption at 24 VDC	50 mA (peak max. 0.5 A)
Output	PNP/NPN (push-pull)
Max. response time	
- TOF/Start Basic	200 ms
- TOF/Start Advanced	
• Area without cross-traffic < 1 m	200 ms
• Area with cross-traffic > 1 m	400 ms
Min. switching time	200 ms
Power-on time	1 s

Connection cable and electrical connection

Sensor

Length	0.25 m
Connection	M8, 6-pin
Diameter	Ø 4.2 mm
Material	PVC, black
Plug color	Blue

Connection cable

Length	2 m (other lengths on request)
Connection	M8, 6-pin
Diameter	Ø 4.2 mm
Material	PVC, black
Plug color	Blue
Wires	AWG26
• brown	U _{sp}
• blue	GND (0 V)
• black	Output
• white	Not connected
• gray	Selectable output logic
• green	Not connected

General

Eye safety	EN 62471:2008
EMC emission	EN 61000-6-3:2007 EN 12015:2014
EMC immunity	EN 61000-6-2:2005 EN 12016:2013
Vibration	IEC 60068-2-6:2007
Shock	IEC 60068-2-27:2008
RoHS	2011/65/EU
Certificate	CE

17. Dimensions

17.1 Sensor

Measurements (all dimensions in mm and inches)

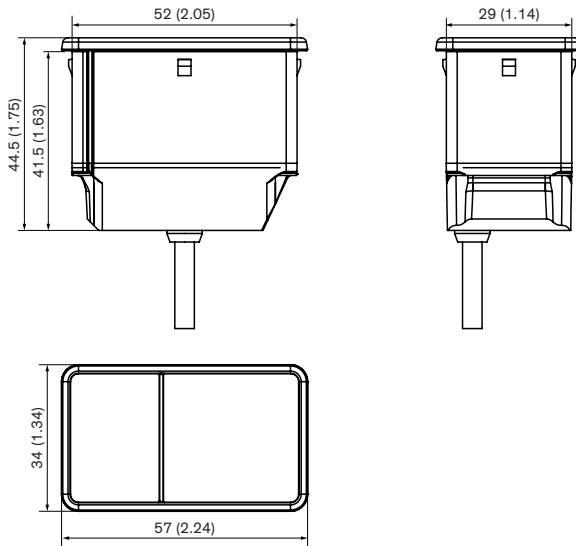

17.2 Mounting bracket

Measurements (all dimensions in mm and inches)

