

... multiple fork type light barrier for intelligent positioning



Features

- Three individual channels
- Large light reserve of 2,500%
- Indication LED for each channel
- High repetitive accuracy of 0.5 mm
- Insensitive to smoke, dust and vapor
- Robust design with two microprocessors
- Short response time
- Short-circuit safe semiconductor output PNP
- High EMC immunity

Technical data

Optical

Light reserve	min. 2,500%
Ambient light	max. 100,000 Lux
Repetitive accuracy	0.5 mm
Wave length IR	950 nm
Number of beams / elements	3

Electrical

Supply voltage U_{SP}	12 ... 60 VDC
Current consumption	< 100 mA
Response time	< 1 ms
Capacitive load	10 μ F
Output range per channel	U_{SP} / GND (0 V), 200 mA (PNP)
- Output logic inner beam (CH1)	NC - light beam free: U_{SP}
- Output logic middle beam (CH2)	NO - light beam free: GND (0 V)
- Output logic outer beam (CH3)	NO - light beam free: GND (0 V)
Indication LED (CH1 - CH3)	On, if light beam interrupted

Mechanical

Dimensions (in mm)	72 x 72 x 20
Fork width	26 mm
Enclosure rating	IP65 (similar to NEMA type 4)
Temperature range	-20 ... +65°C

Cables

Type	AWG24
Diameter	Approx. 5.5 mm
Length	0.3 m
Color	Black

Electrical connections

Brown	12 ... 60 VDC
Blue	GND (0 V)
White	Channel 1, PNP
Gray	Channel 2, PNP
Green	Channel 3, PNP

General

EMC / EMI	EN 12015 / EN 12016
Certificates	CE

Dimensions

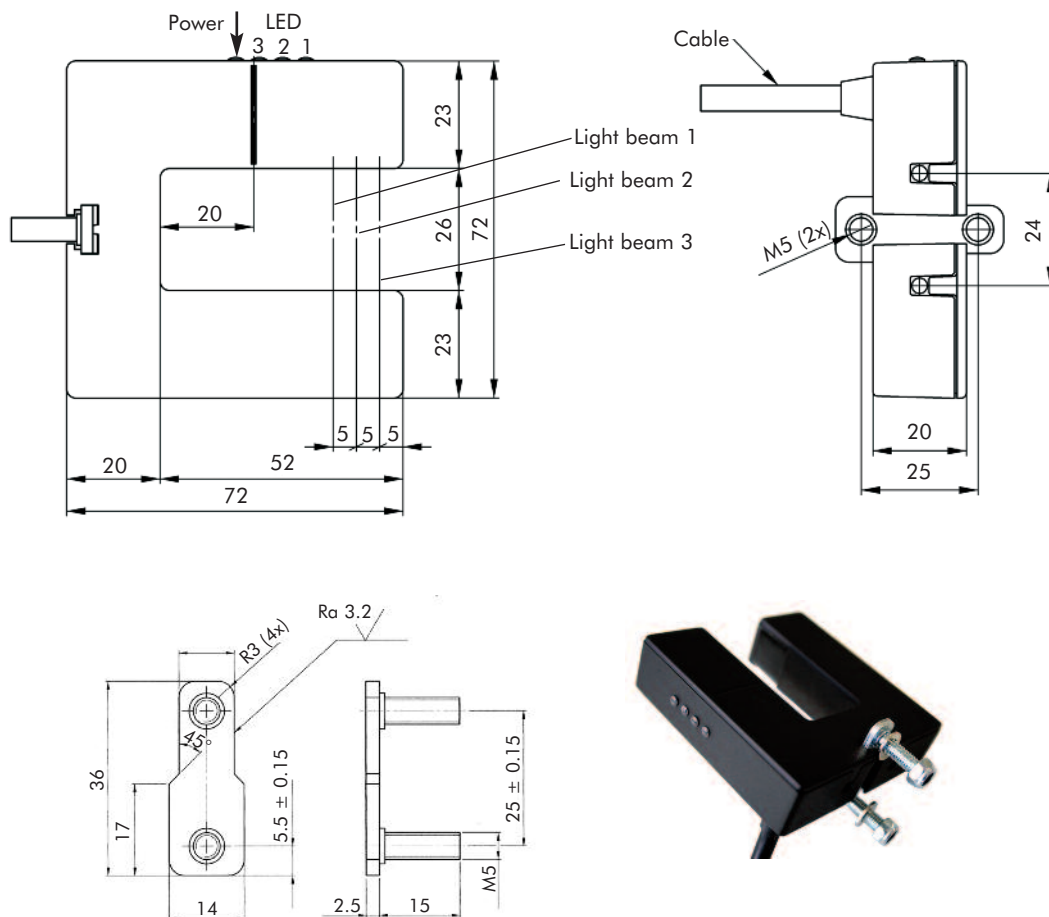

(All dimensions in mm)

Block circuit diagram

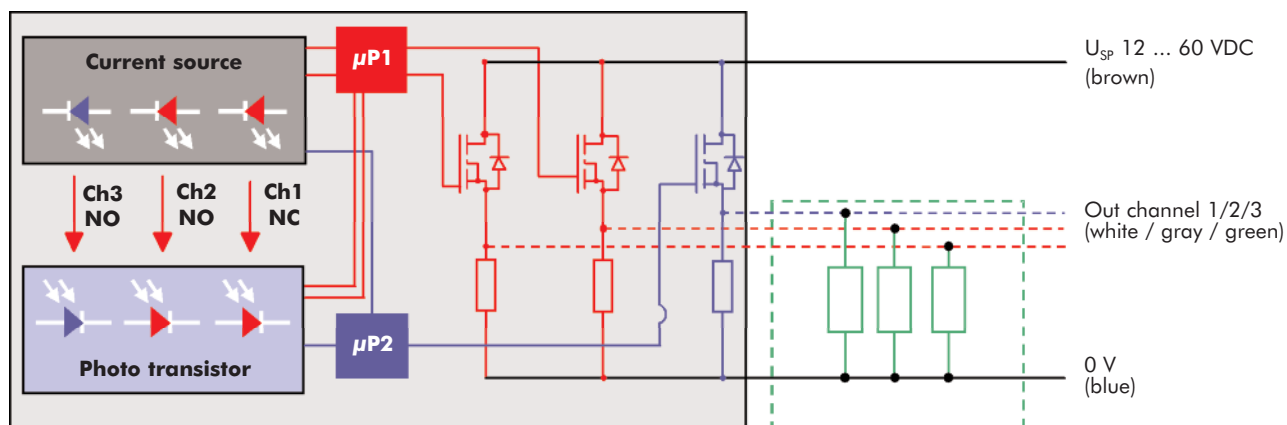

Output logic definition

Status	Output 1 (white)	LED 1	Output 2 (gray)	LED 2	Output 3 (green)	LED 3
Interrupted	0 V	ON	+ U _{SP} (12 ... 60 V)	ON	+ U _{SP} (12 ... 60 V)	ON
Not interrupted	+ U _{SP} (12 ... 60 V)	OFF	0 V	OFF	0 V	OFF

Ordering information

Part no.	Type	Description
106 137	GLS 326	Complete system with three beams, PNP, with 0.3 m cable (high capacitive load - HCL)
106 146	Accessory	Fixing unit for GLS 326

Other configurations on request

CEDES AG / Switzerland • Tel. +41 81 307 2323 • Fax +41 81 307 2325 • info@cedes.com • www.cedes.com

CEDES AG is certified according to ISO 9001: 2008. CEDES AG reserves the right to modify or change technical data without prior notice.